

FIG. 1

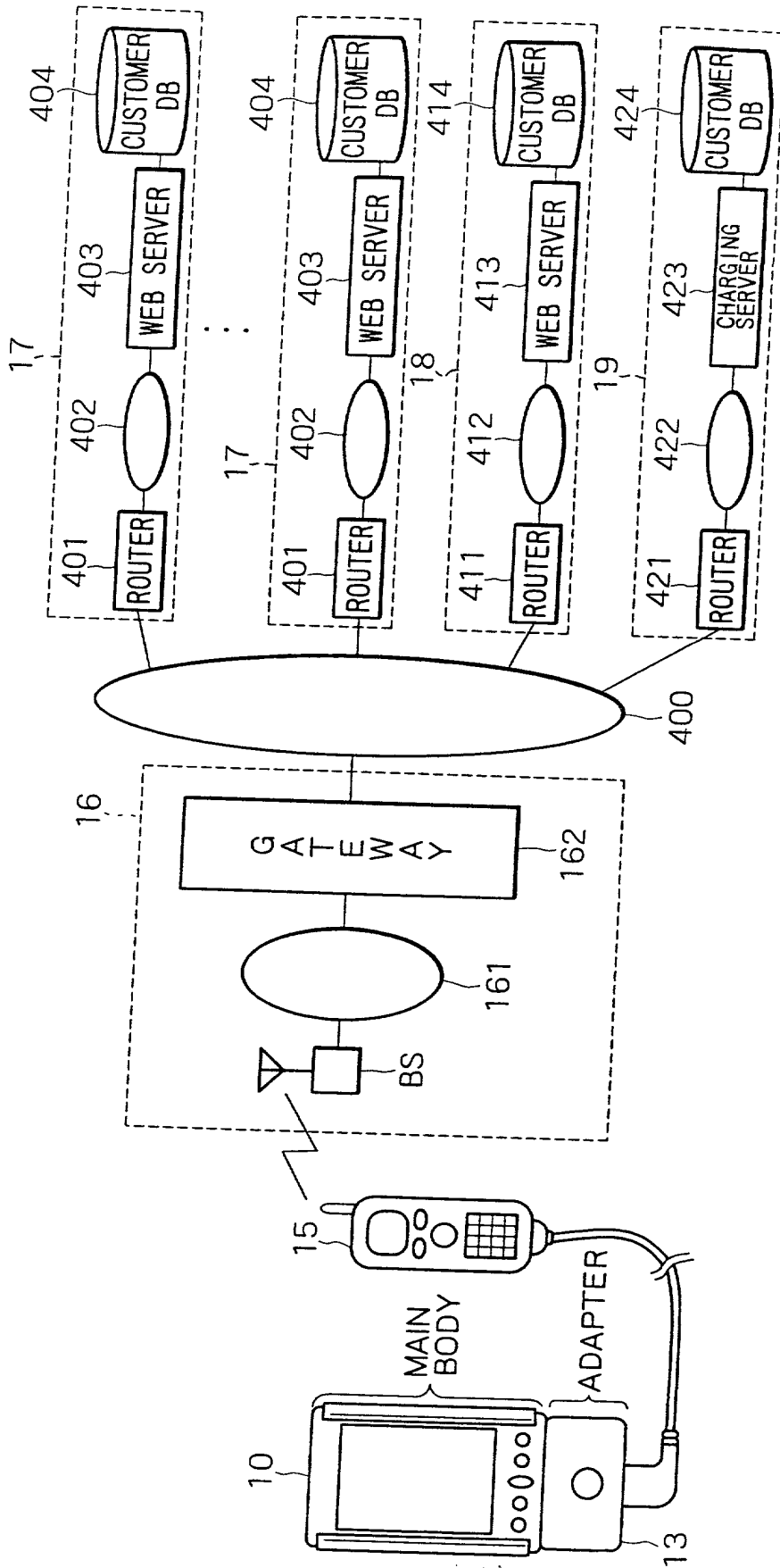

FIG. 2

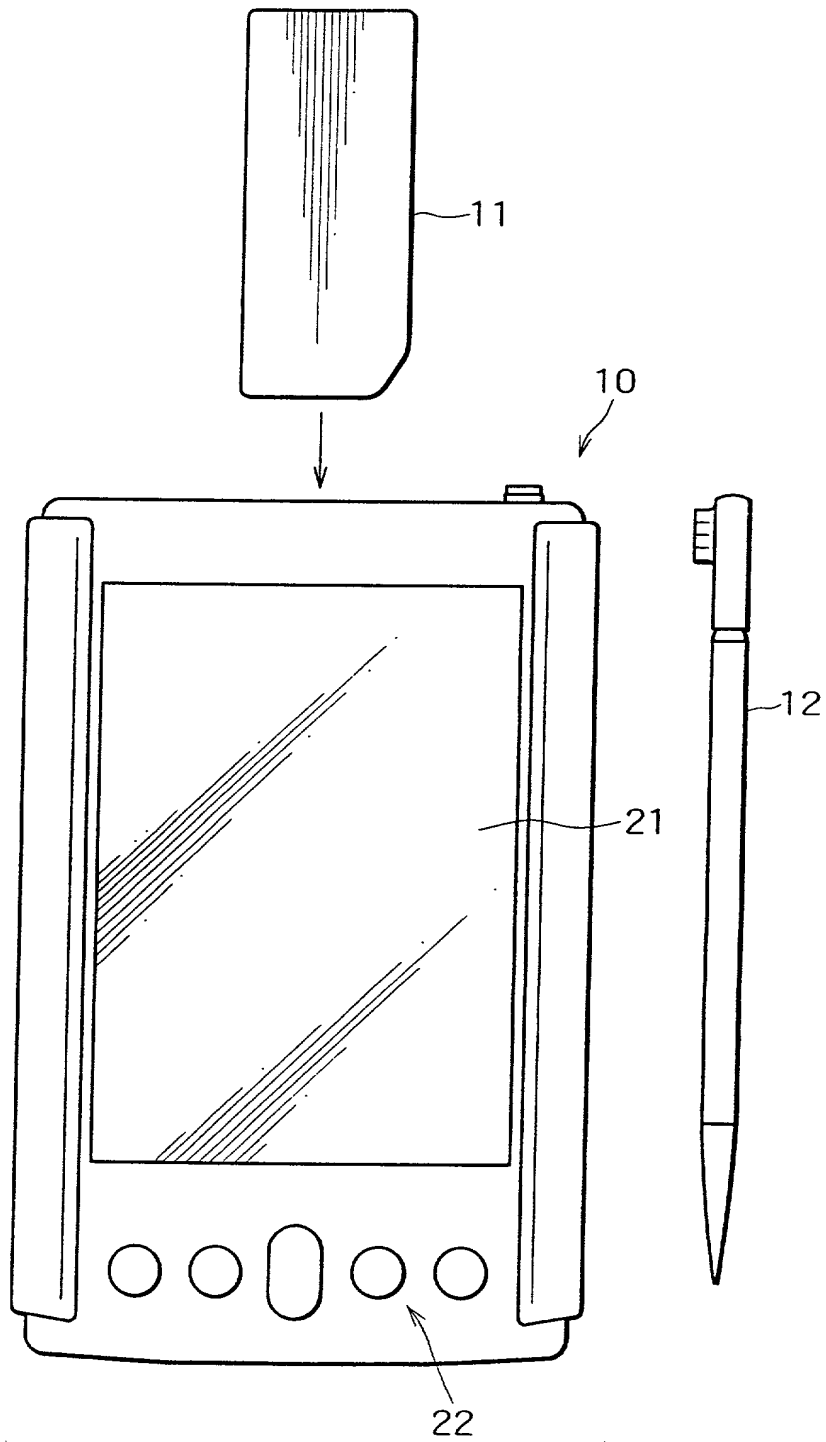

FIG. 3

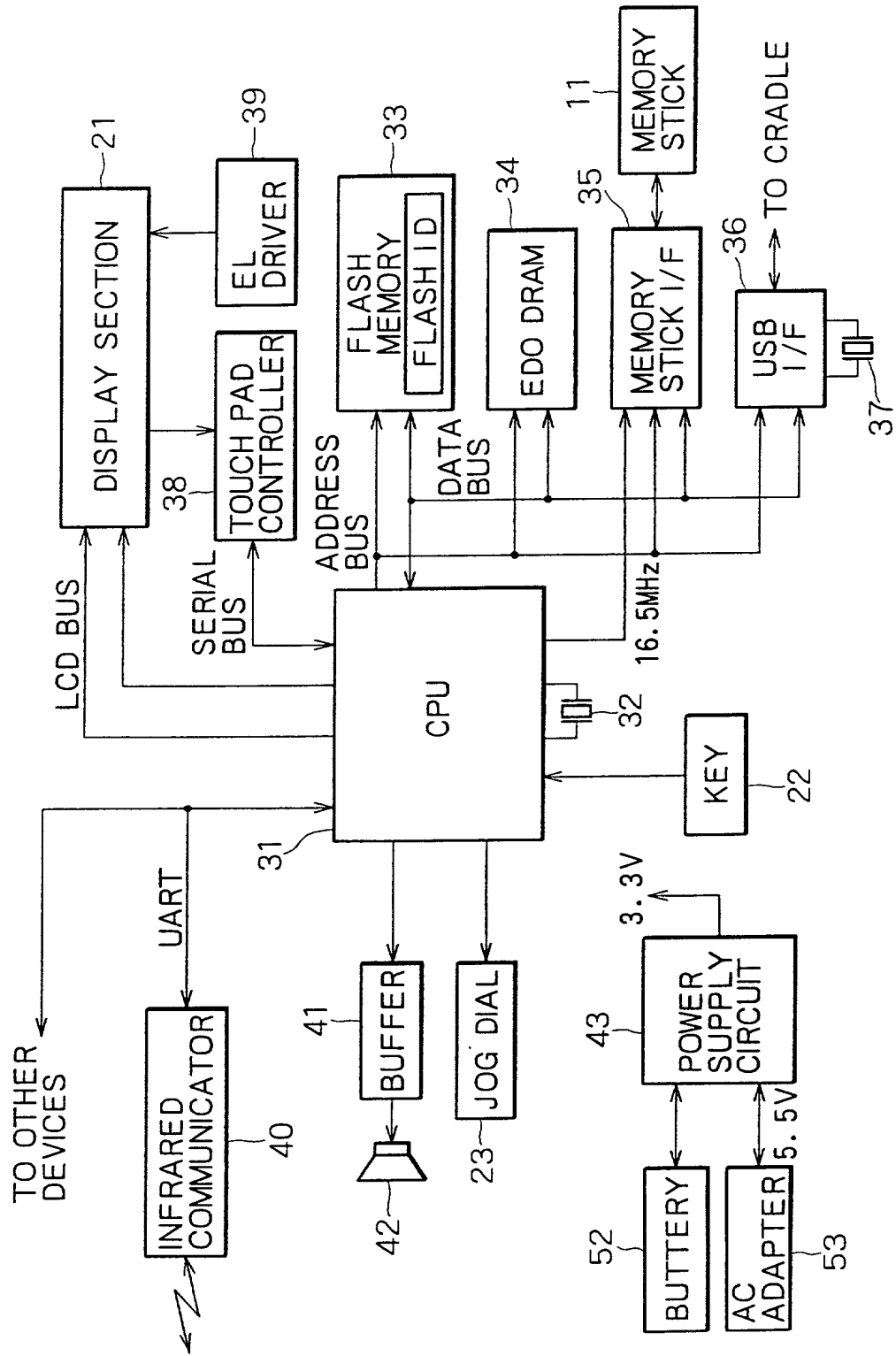

FIG. 4

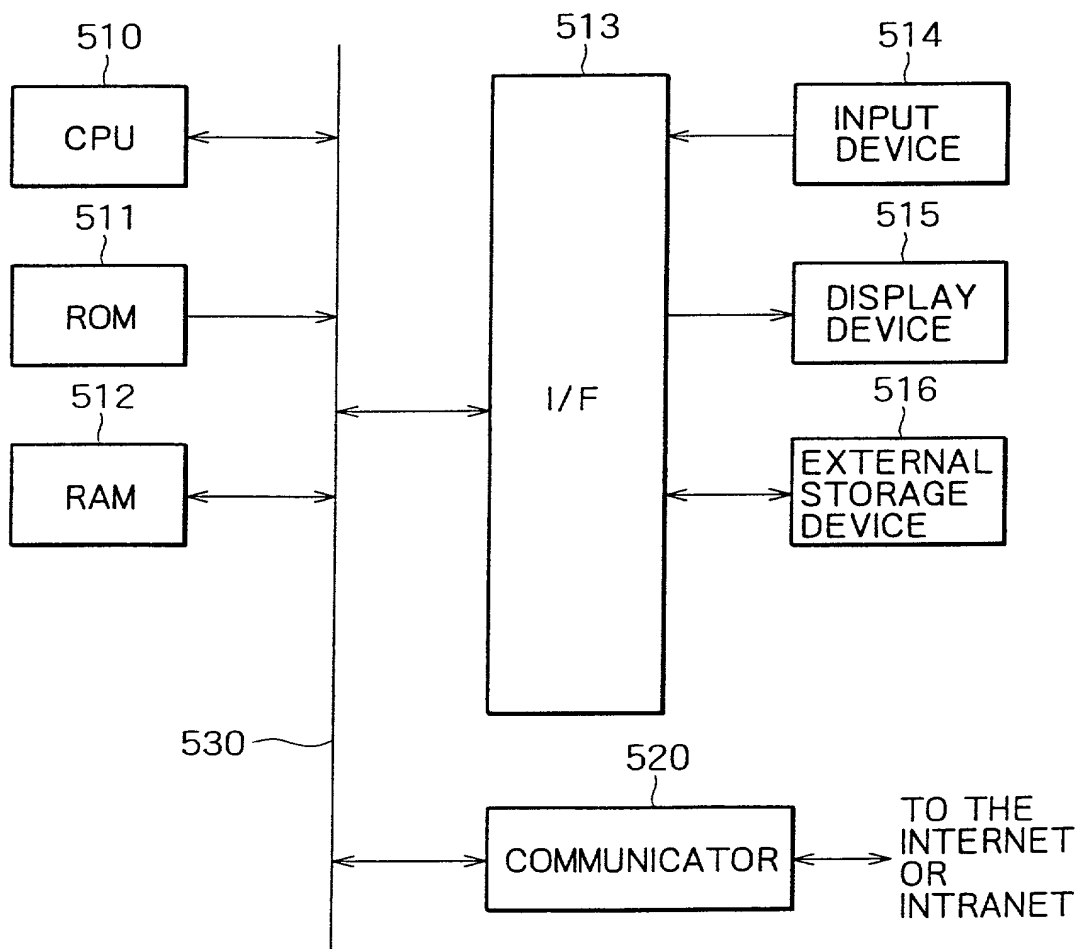

FIG. 5

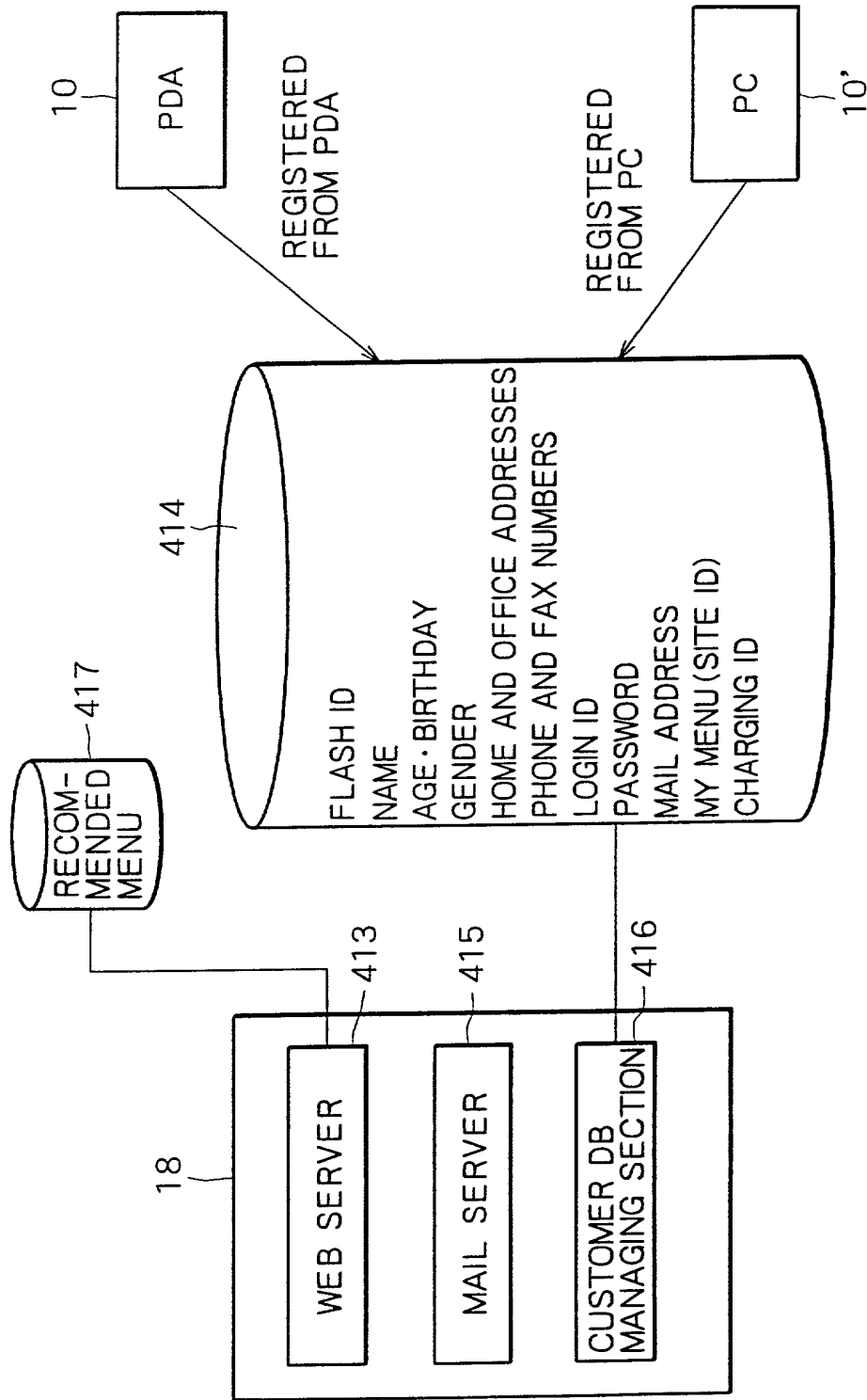

FIG. 7

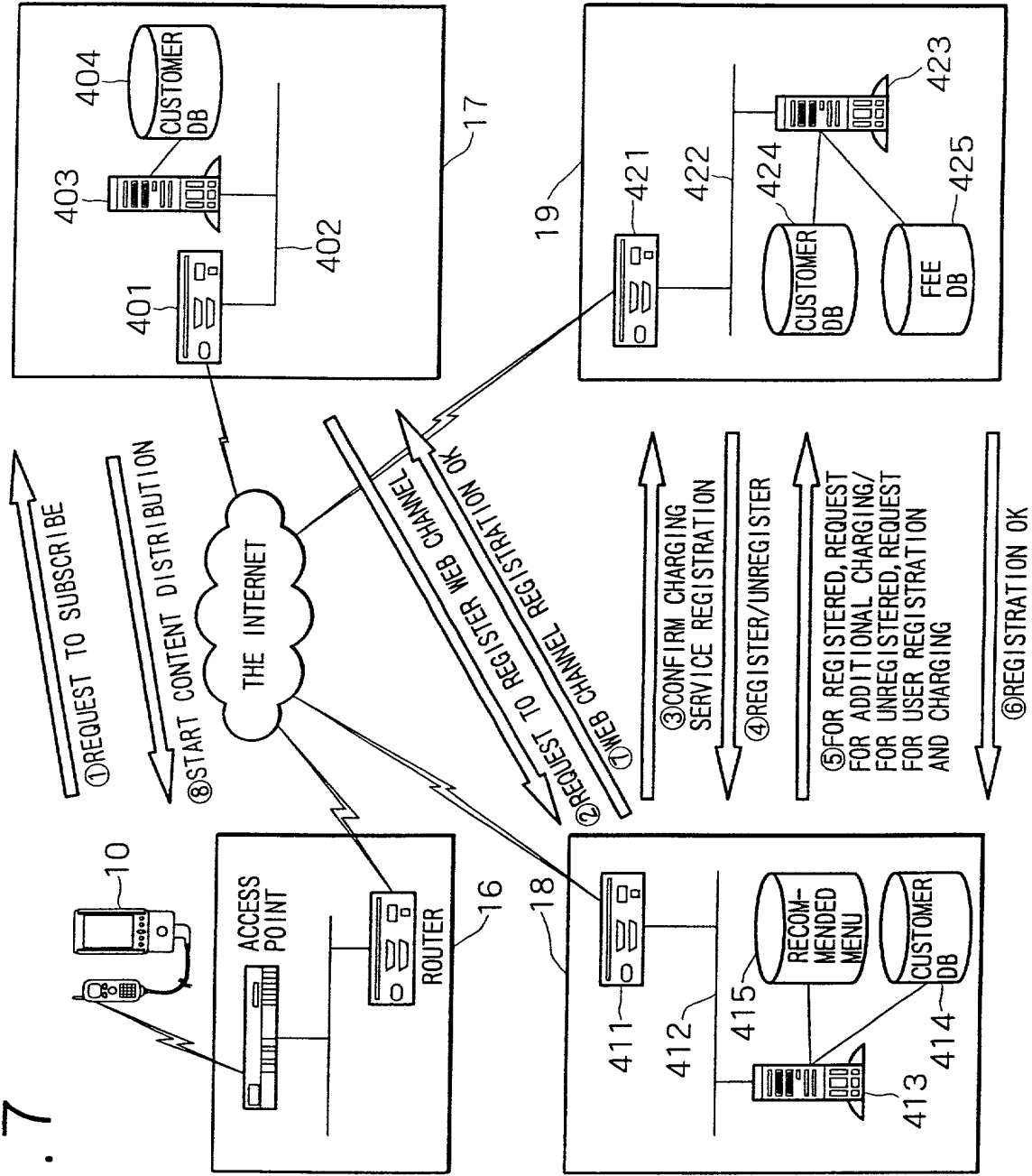

FIG. 7

FIG. 8

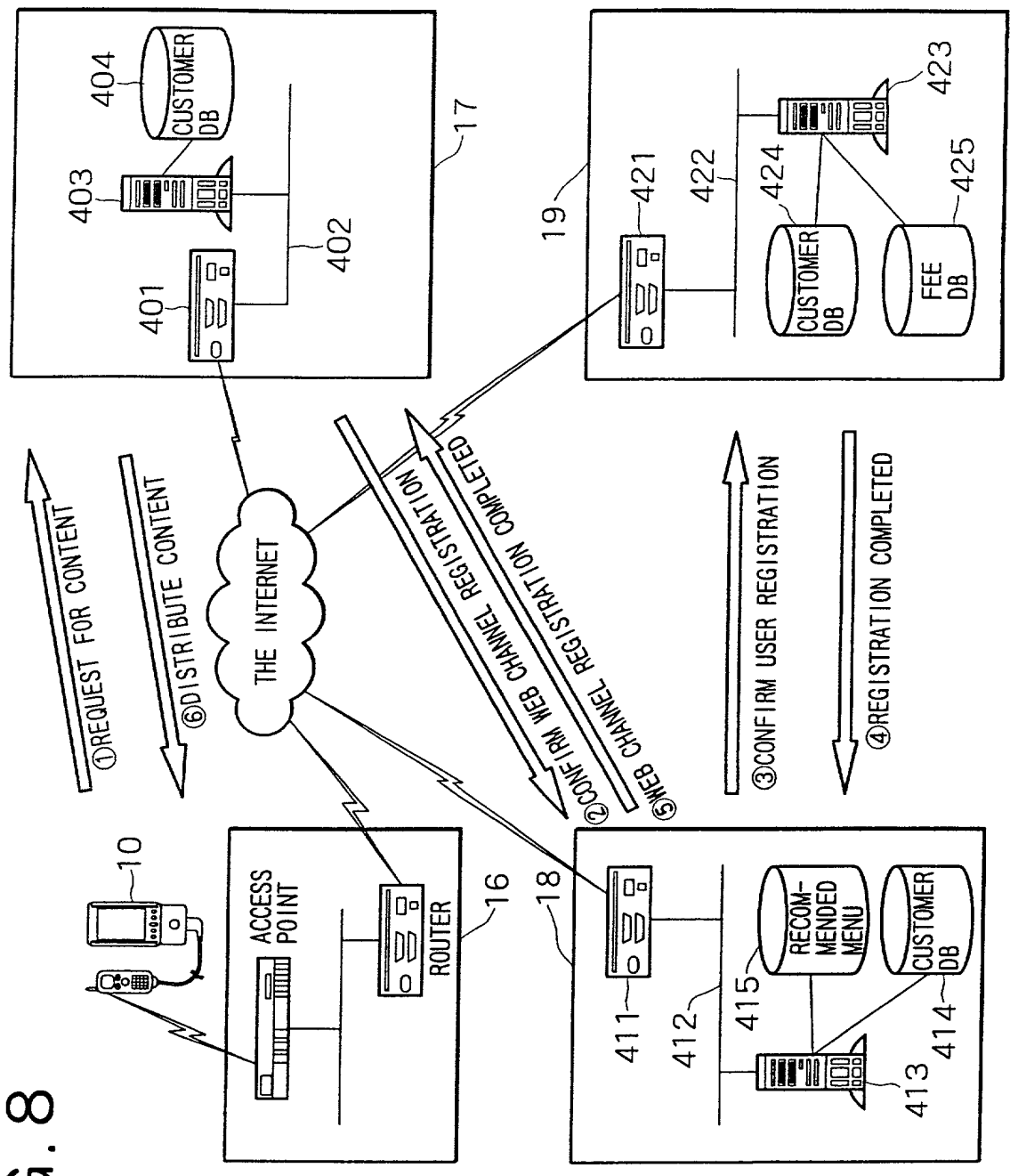

FIG. 8 is a block diagram of a network system and a registration process.

FIG. 9

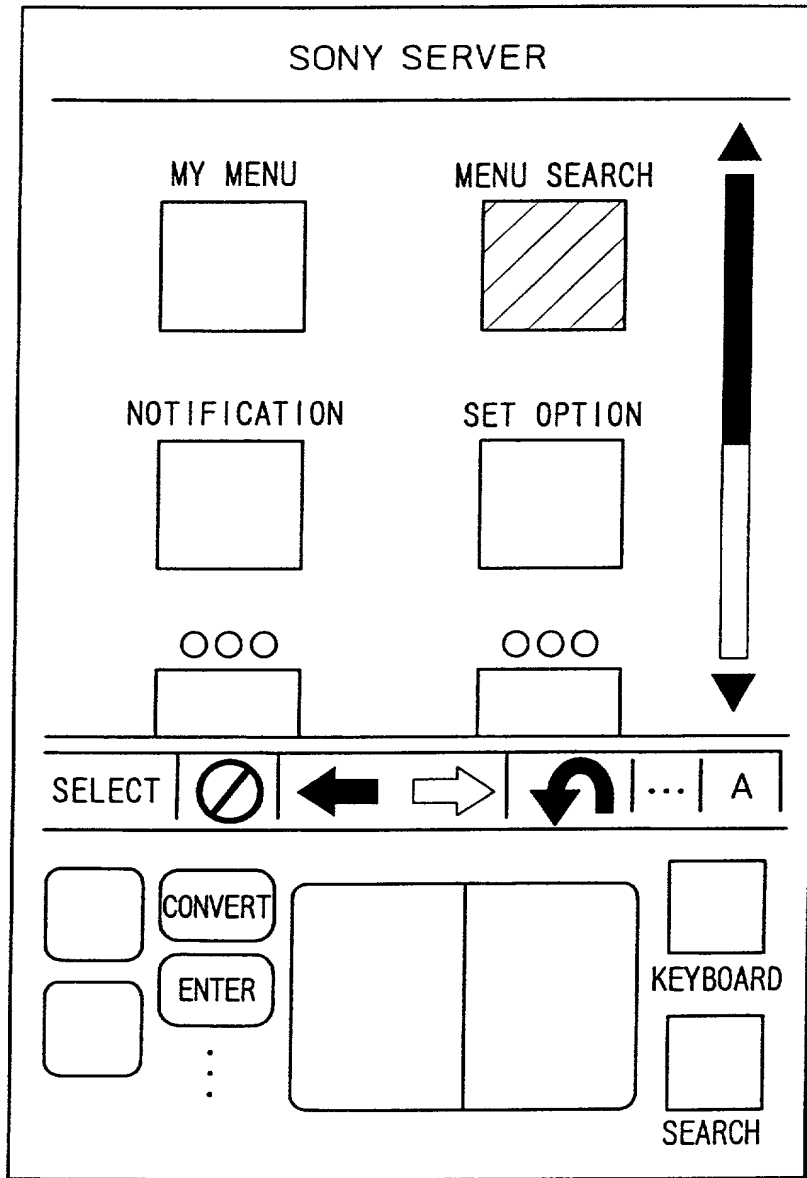

FIG. 10

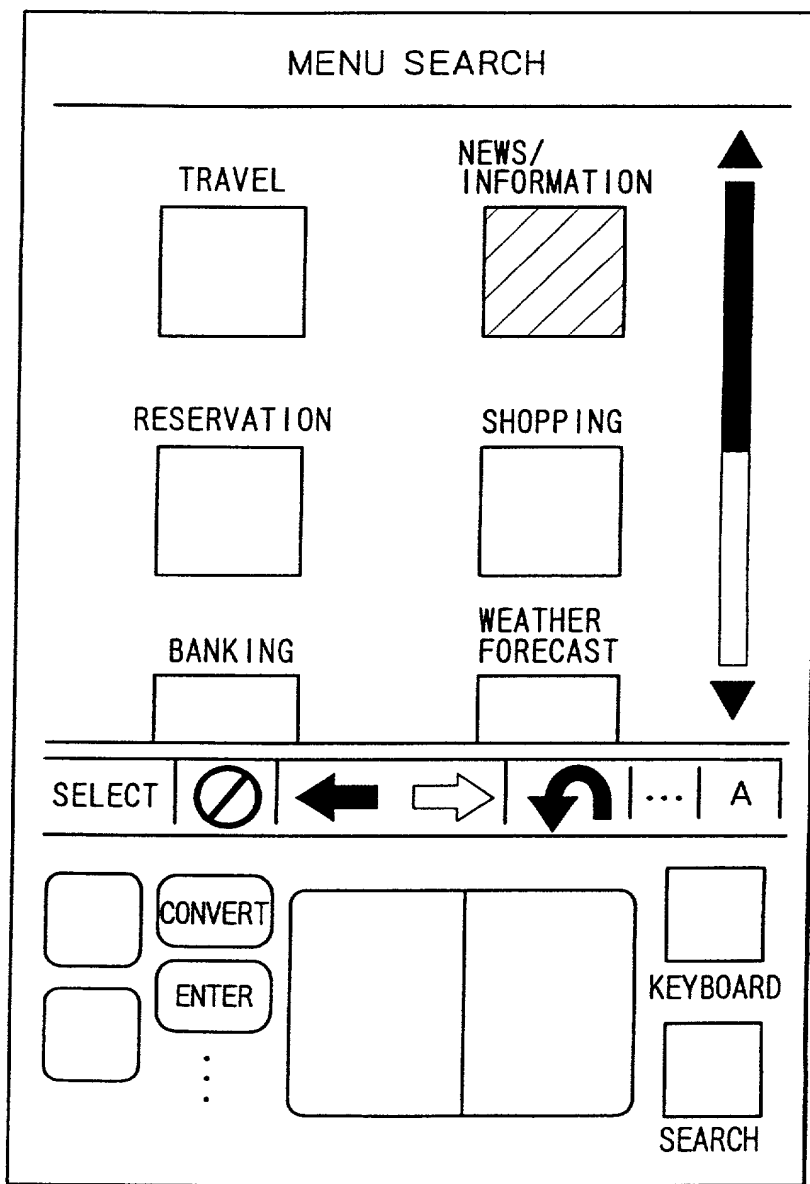

FIG. 11

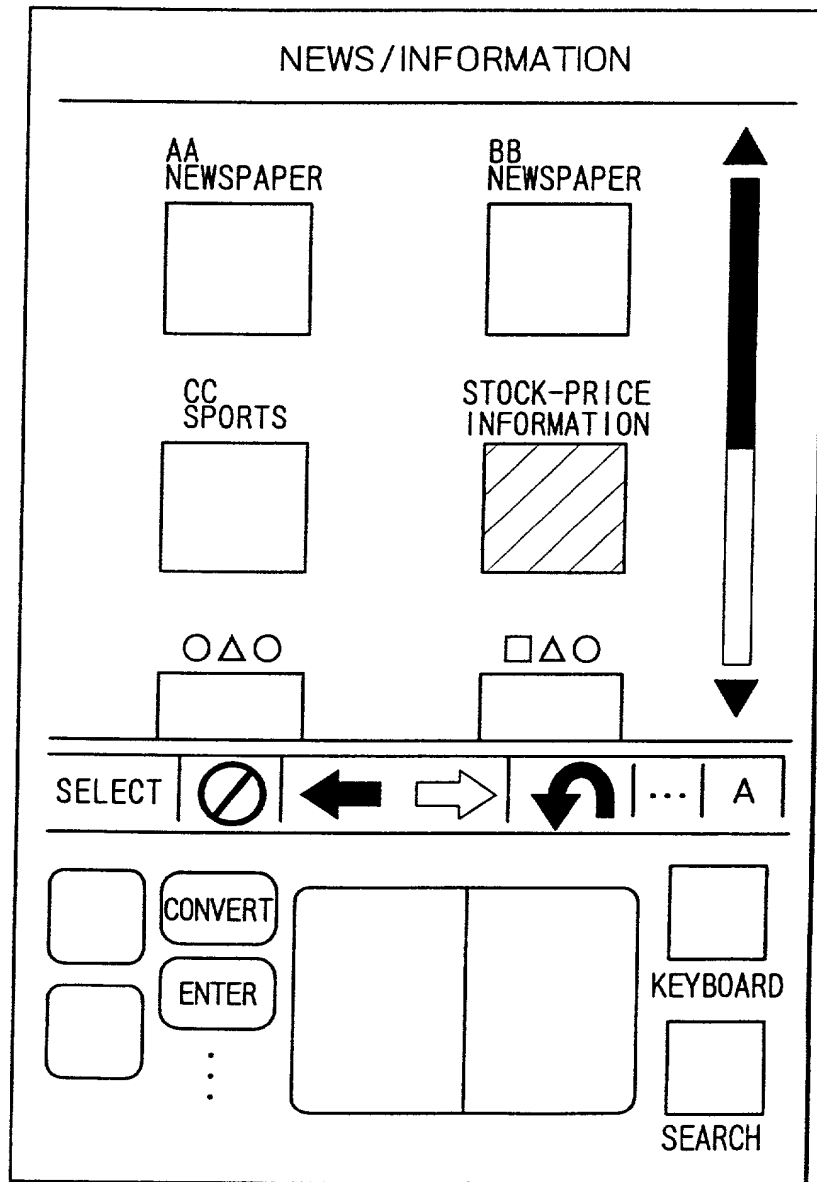

FIG. 12

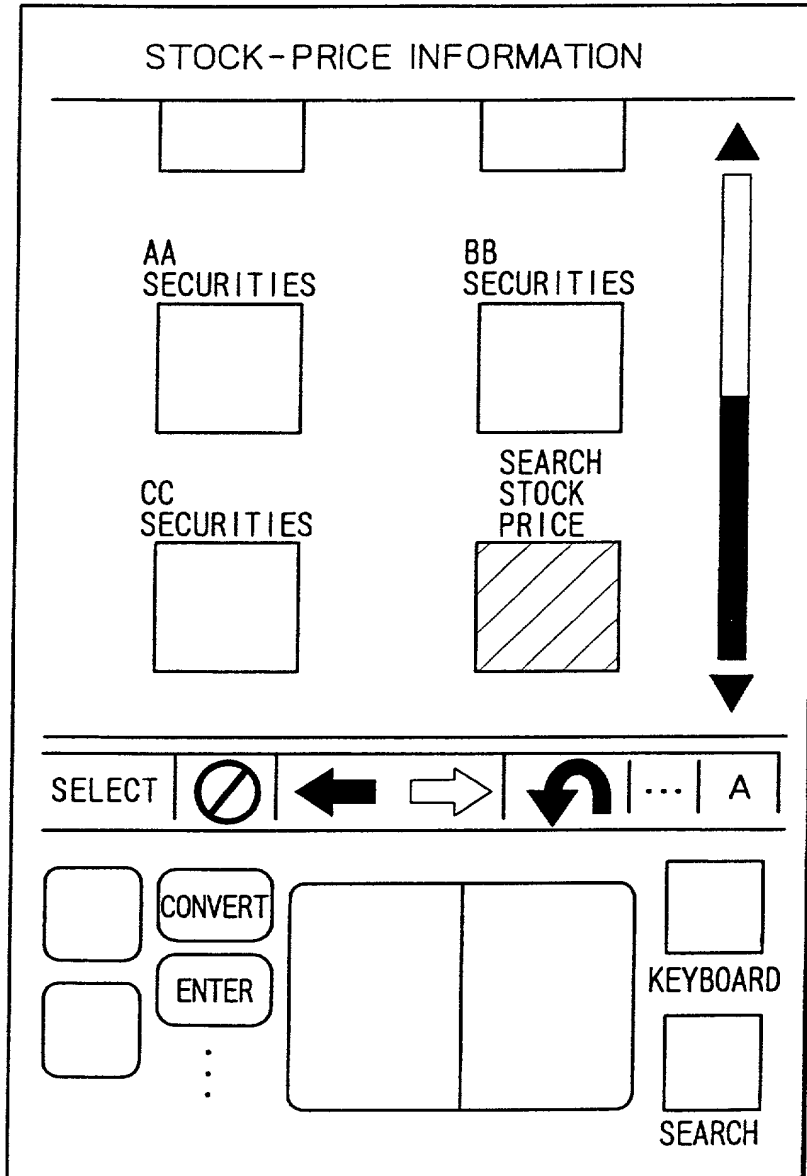

FIG. 13

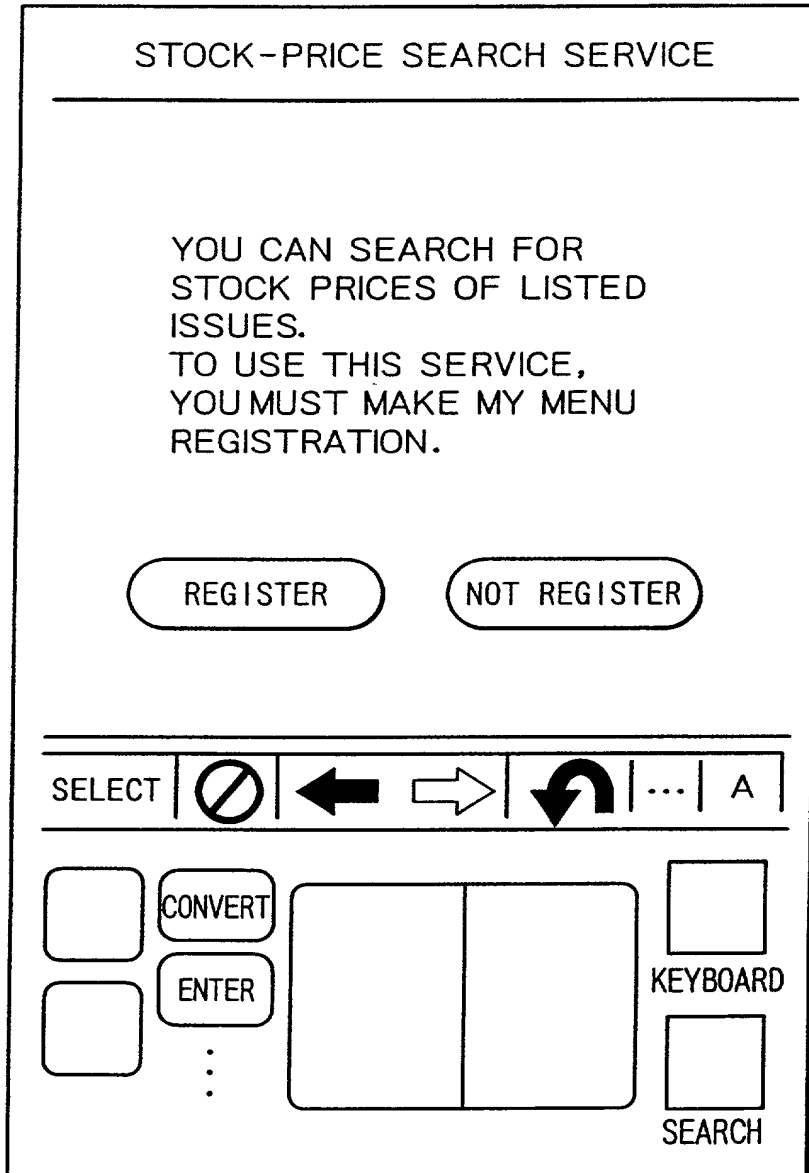

FIG. 14

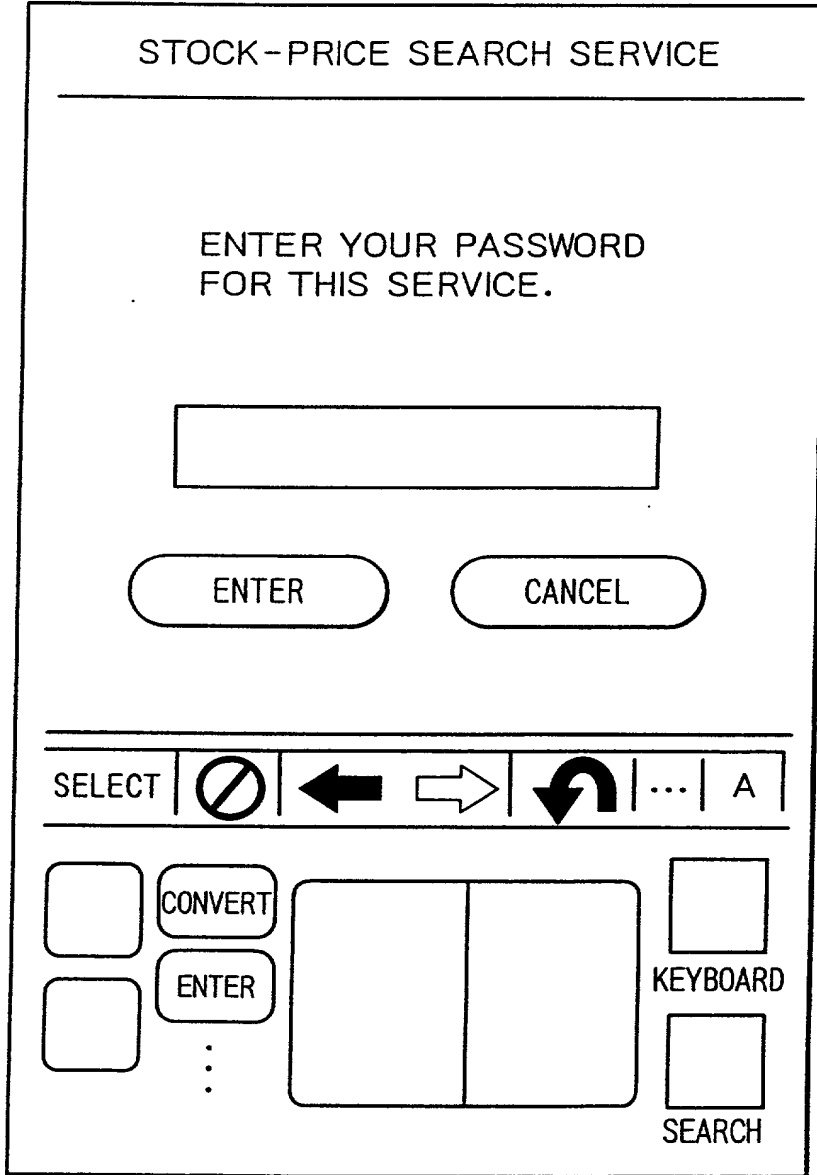

FIG. 15

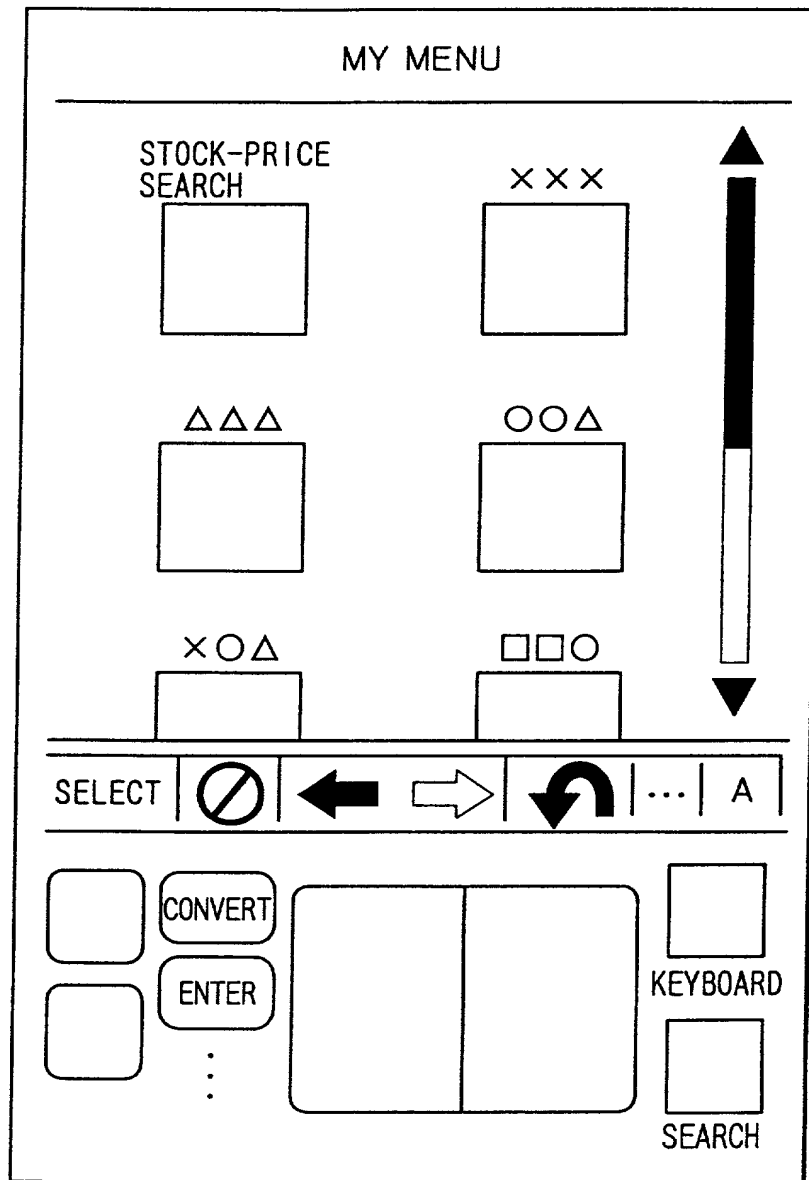

FIG. 16

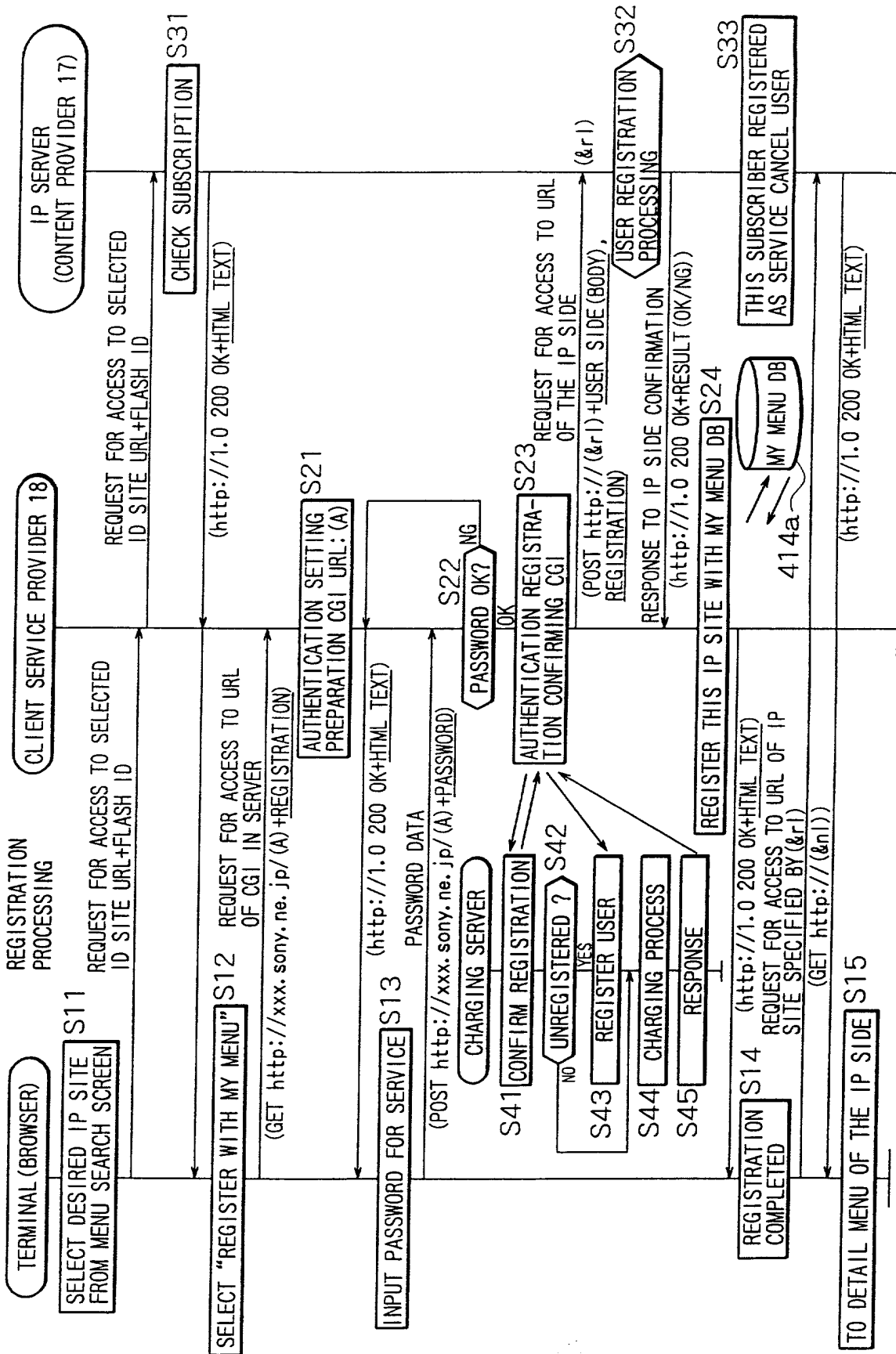

FIG. 17

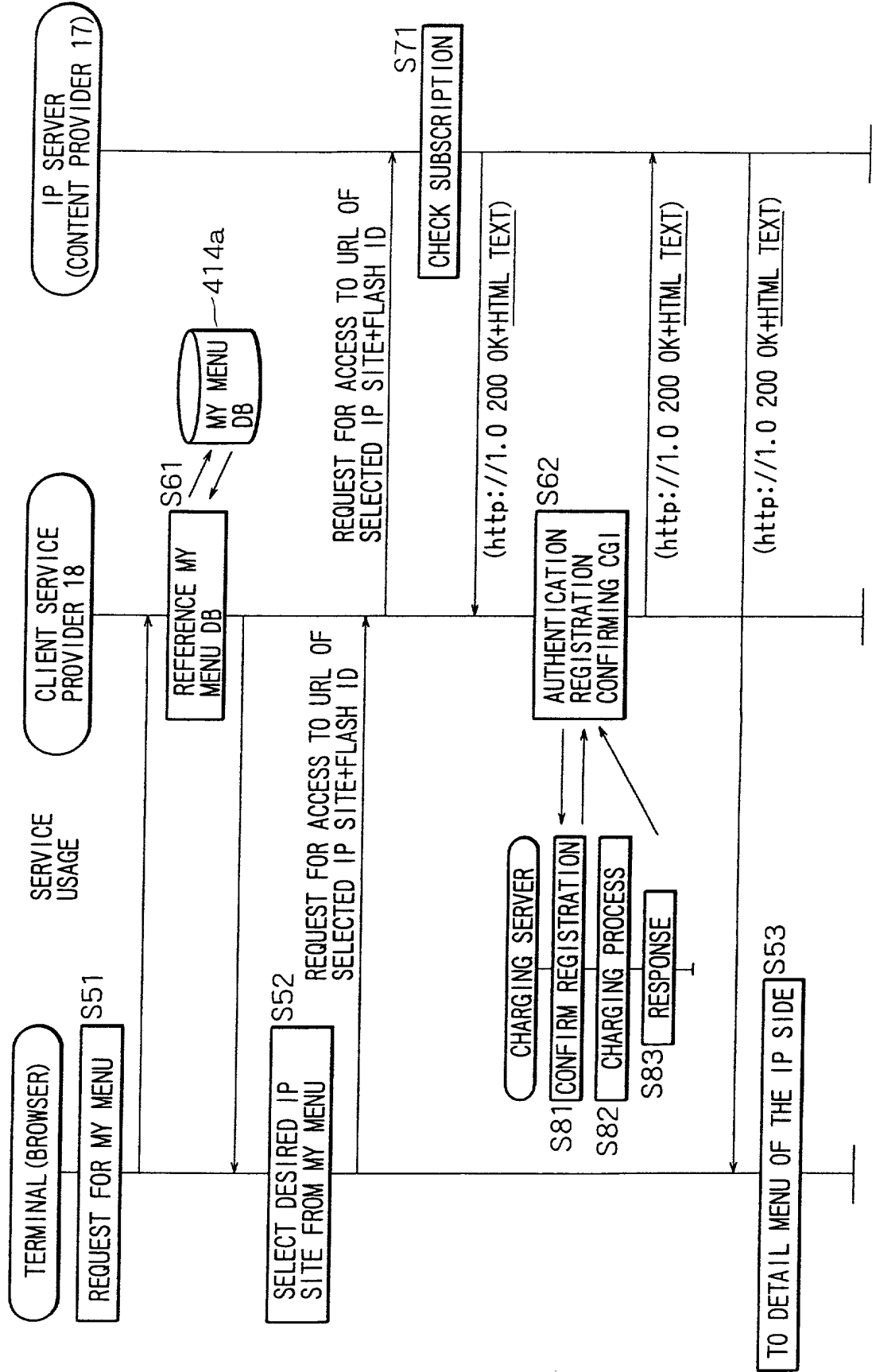

FIG. 18

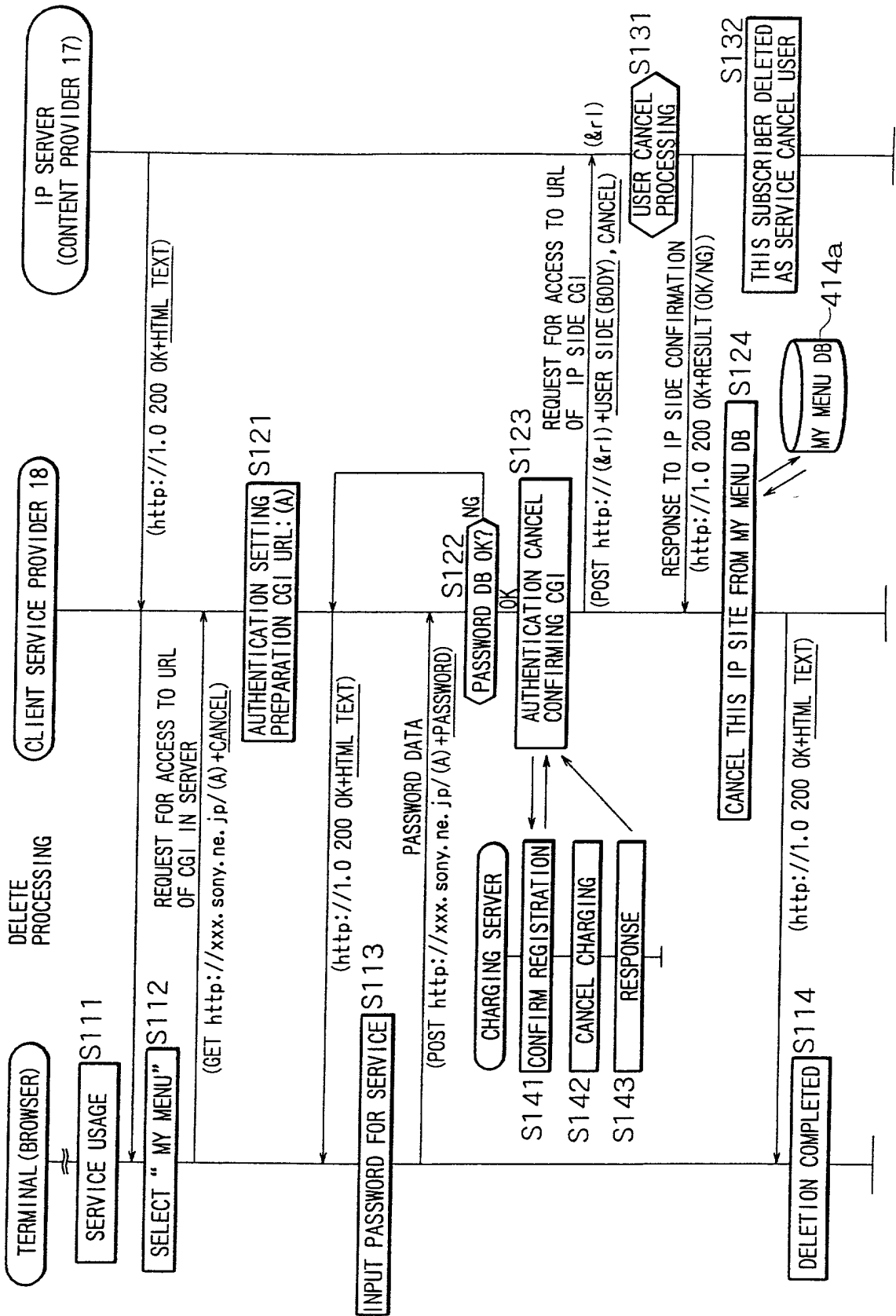
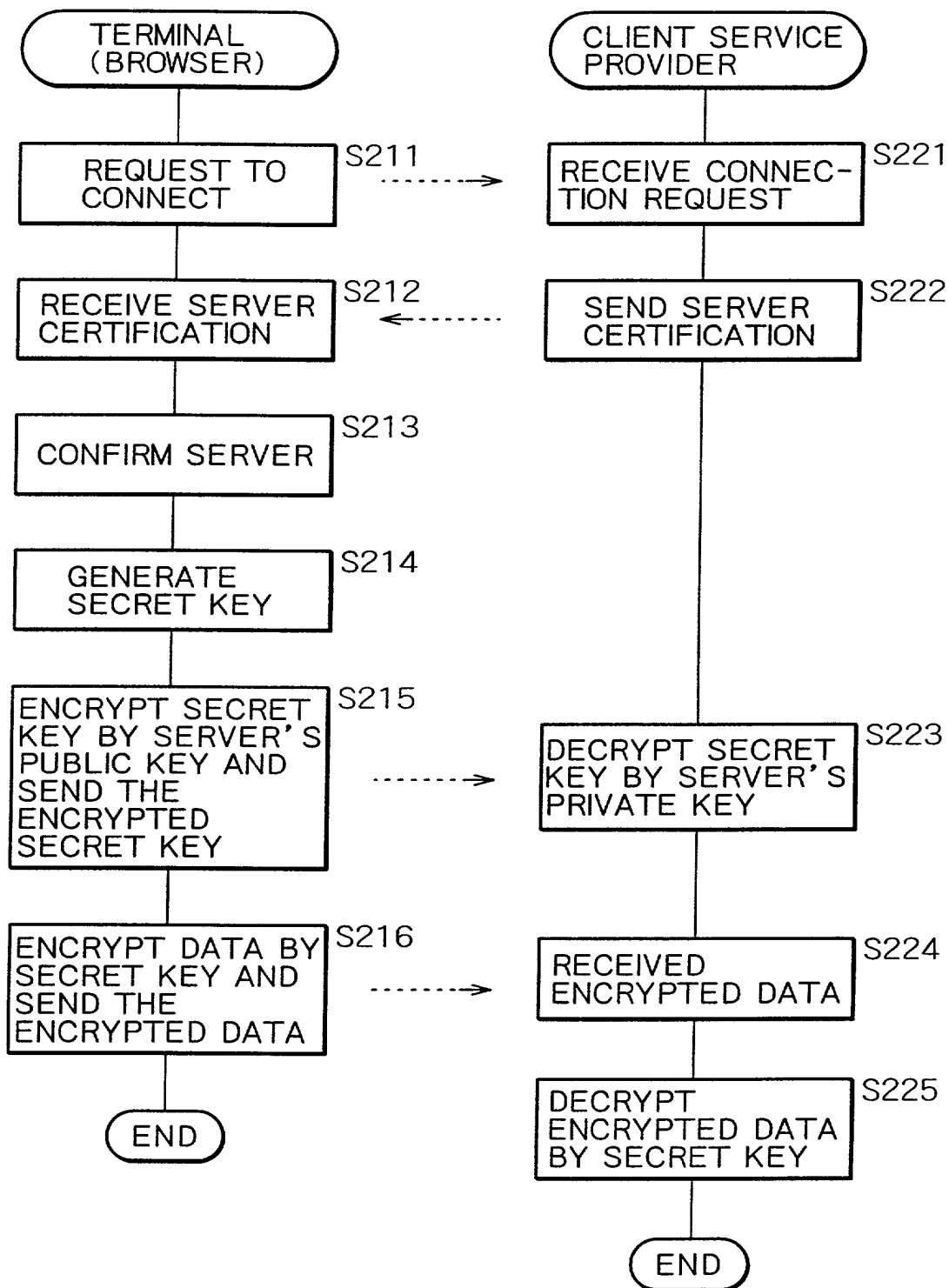

FIG. 19

SSL ENCRYPTION PROCESSING



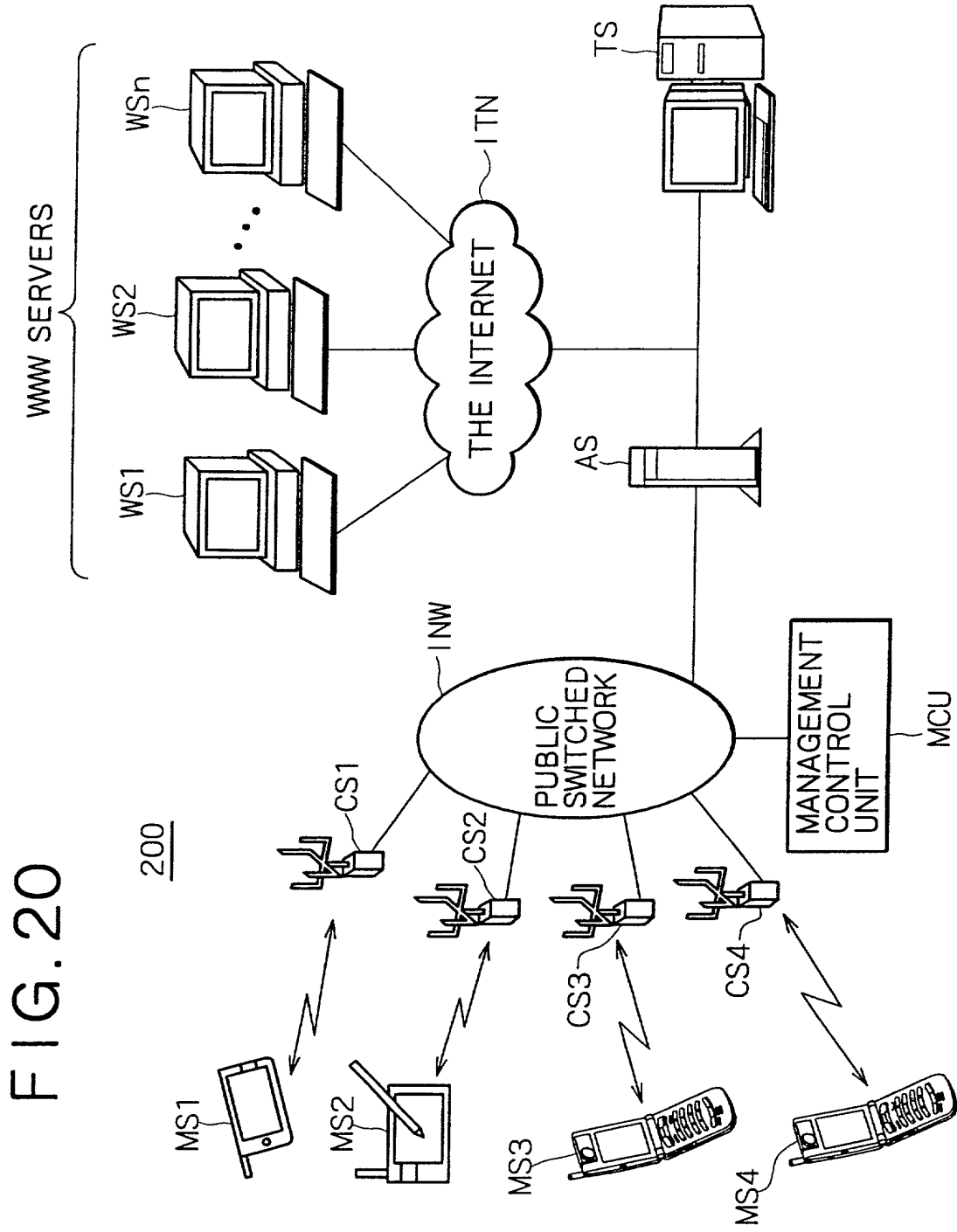

FIG. 20

FIG. 20 is a schematic diagram of a network architecture.

FIG. 21

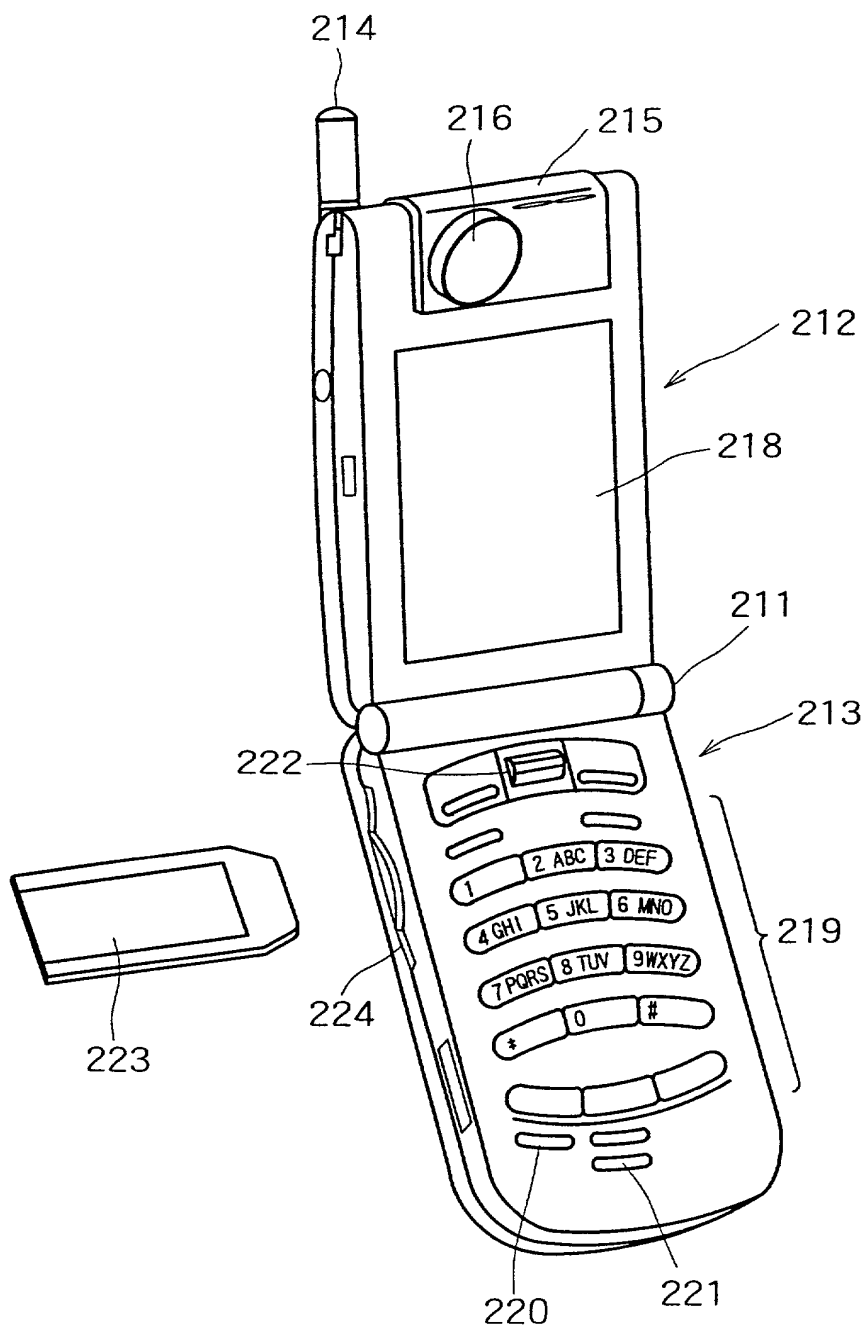

FIG. 22

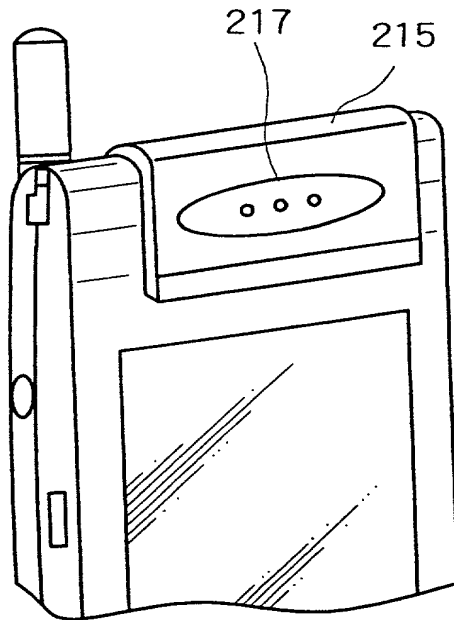

FIG. 23

